

# EMOSAFE EN-70

Product Datasheet

## Ultra-compact Network Isolators



## 1 FEATURES AND ADVANTAGES

- Ultra-compact
- Gigabit Ethernet
- 5.0 kV AC dielectric strength \*
- 8.5 kV DC dielectric strength
- Suitable for stand-alone operation as well as incorporation into racks, devices, and products
- Suitable for use within medical supply units
- Conforms to IEC 60601-1
- UL Recognized Component
- ISO 11801 Class D Ethernet performance is achievable in permanent links which include the isolator
- Extremely low insertion losses; thereby total cable lengths of 100 metres are achievable
- Transient voltage suppression on all signal lines \*
- Suitable for devices with supply voltages up to 400 V AC
- RoHS compliant
- 100% inspection by our Quality Control

## 2 GENERAL DESCRIPTION

EMOSAFE EN-70 Network Isolators disconnect every electrically conducting connection (specifically the data and shield conductors) between devices connected together via a copper-based Ethernet network. The Network Isolators prevent current flow resulting from differences in electrical potentials, and also protect connected devices and their users from stray external voltages and power surges which may be directly or inductively coupled onto the network lines by causes such as installation errors, lightning, switching operations, and electrostatic discharge.

*\* With the exception of EN-70e, which provides a dielectric strength of only 4.6 kV AC and does not provide any transient voltage suppression.*

Built into a medical electrical (ME) product, the EMOSAFE EN-70 Network Isolator facilitates the safe Ethernet connection of this ME product within the patient environment. The EN-70 satisfies all construction requirements of IEC 60601-1 in the formation of two means of patient protection (MOPP) within the network interface, thereby practically eliminating the risk of electrical shocks arising from such stray external voltages at the network connection. With its UL approval, the EN-70 is also suitable for devices destined for export to the North American markets.

Above all, the EMOSAFE EN-70 Network Isolators are characterized by their particularly small installation size and their universal applicability. An overview of the available models can be found in section [4 SUMMARY OF VARIANTS](#).

For all EN-70 variants, with the exception of stand-alone types EN-70HD and EN-70e, the outgoing plug socket at the rear can be ordered either in a straight (H) or a 90° angled (V) format.

With the exception of EN-70e, the EN-70 series offers a particularly effective level of device protection. Voltage spikes on individual signal conductors are eliminated by means of a supplementary TVS diode circuit. These transient voltages cannot be repressed by conventional network isolators.

Low-frequency signal components are strongly attenuated, so that connected devices may, for example, be protected against ground loops.

EMOSAFE Network Isolators transmit high-frequency signals through the principle of electromagnetic induction. Because of this, they do not require their own power supplies. There are no software drivers to be installed.

## 3 APPLICATIONS

---

### 3.1 PATIENT PROTECTION

Electrical separation of Ethernet interfaces of medical electrical (ME) devices and systems, where patients must be protected from dangerous leakage currents, in conformity with applicable standards.

### 3.2 EQUIPMENT PROTECTION

Applications, in which valuable devices or those requiring special protection need to be protected against ripple, mains hum, and surge voltages from the network periphery.

### 3.3 MEASUREMENT TECHNOLOGY

Electrical measuring and monitoring equipment, which needs to be protected against external voltages and interference voltages arising from the Ethernet periphery.

### 3.4 POTENTIAL DIFFERENCES (TECHNICAL BUILDING SYSTEMS)

Computer systems, which are electrically connected with each other over significant distances via Ethernet cabling, where current flows caused by potential differences must be prevented.





### 3.5 AUDIO

Audio applications, in which the transmission of low frequency alternating current voltages (mains hum) over the network connection is to be reduced to an imperceptible level.

## 4 SUMMARY OF VARIANTS

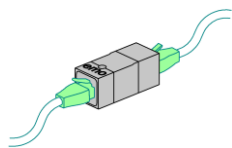
### EN-70

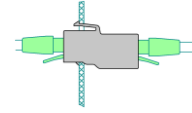
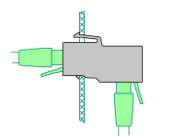
Ultra-compact  
Network Isolators

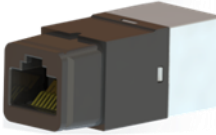
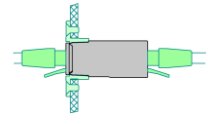
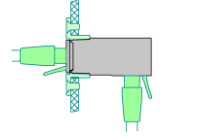
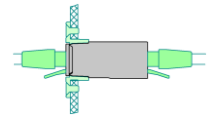
	Name Article number	Special features	AC dielectric strength (kV)	TVS diodes	10/100/1000 Mbit/s	Typical Return Loss (dB) @ 100 MHz	Typical Insertion Loss (dB) @ 100 MHz	Configuration
<b>Standard</b>  	<a href="#">EN-70e</a> A10053	Economy plug-in isolator.  Grey cap.	4.6	✗	✓	17	1.0	
	<a href="#">EN-70HD</a> A10054	High performance plug-in isolator.  Black cap.	5.0	✓	✓	20	0.7	
<b>Keystone</b>  	<a href="#">EN-70HD-K</a> A10059	High performance isolators for assembly into Keystone-compatible electrical outlets.	5.0	✓	✓	20	0.7	
	<a href="#">EN-70VD-K</a> A10060		5.0	✓	✓	20	0.7	
<b>SnapFit</b>    	<a href="#">EN-70HD-S</a> A10055	High performance isolators suitable for use with EMOSAFE SnapFit installation frame accessories.	5.0	✓	✓	20	0.7	
	<a href="#">EN-70VD-S</a> A10056		5.0	✓	✓	20	0.7	
	<a href="#">EN-70HD-S-B</a> A10108		5.0	✓	✓	20	0.7	

## 5 DRAWINGS

All dimensions are in millimetres

### 5.1 EN-70HD AND EN-70e

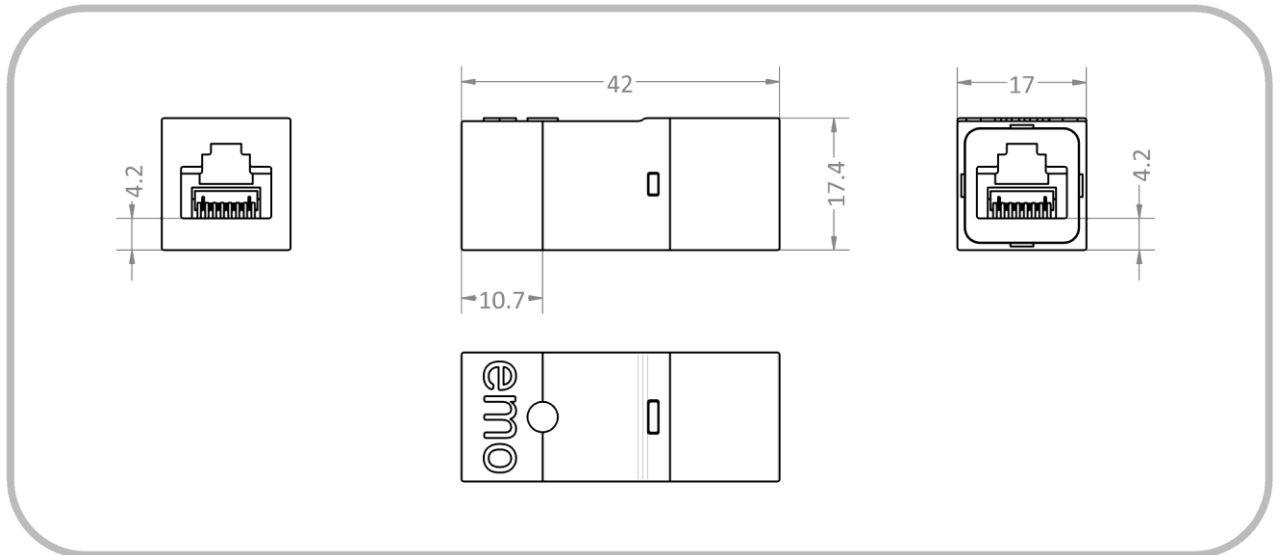

Figure 1. Physical dimensions for EN-70HD and EN-70e

### 5.2 EN-70HD-S; EN-70-HD-S-B

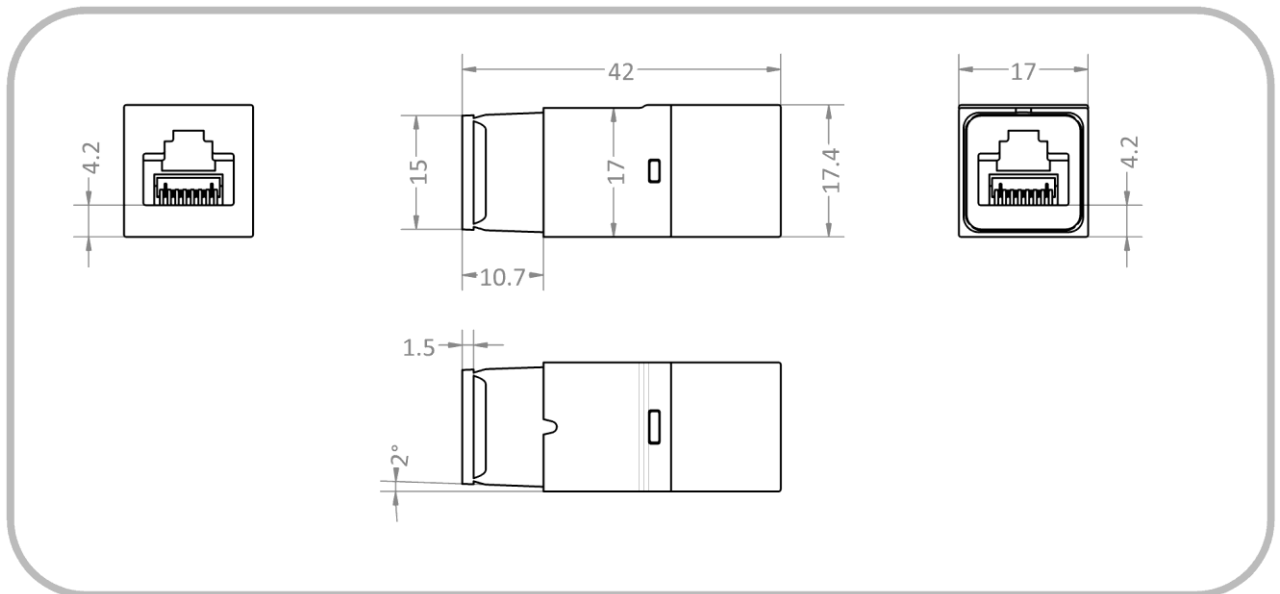

Figure 2. Physical dimensions for EN-70HD-S; EN-70-HD-S-B

5.3 EN-70VD-S

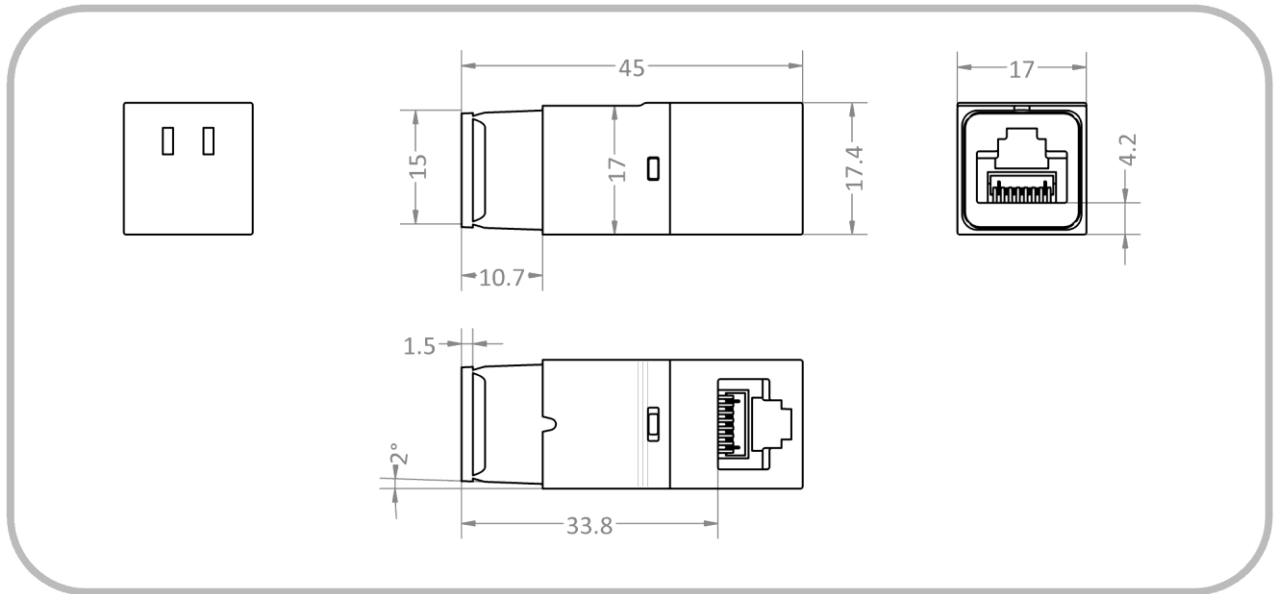

Figure 3. Physical dimensions for EN-70VD-S

5.4 EN-70HD-K

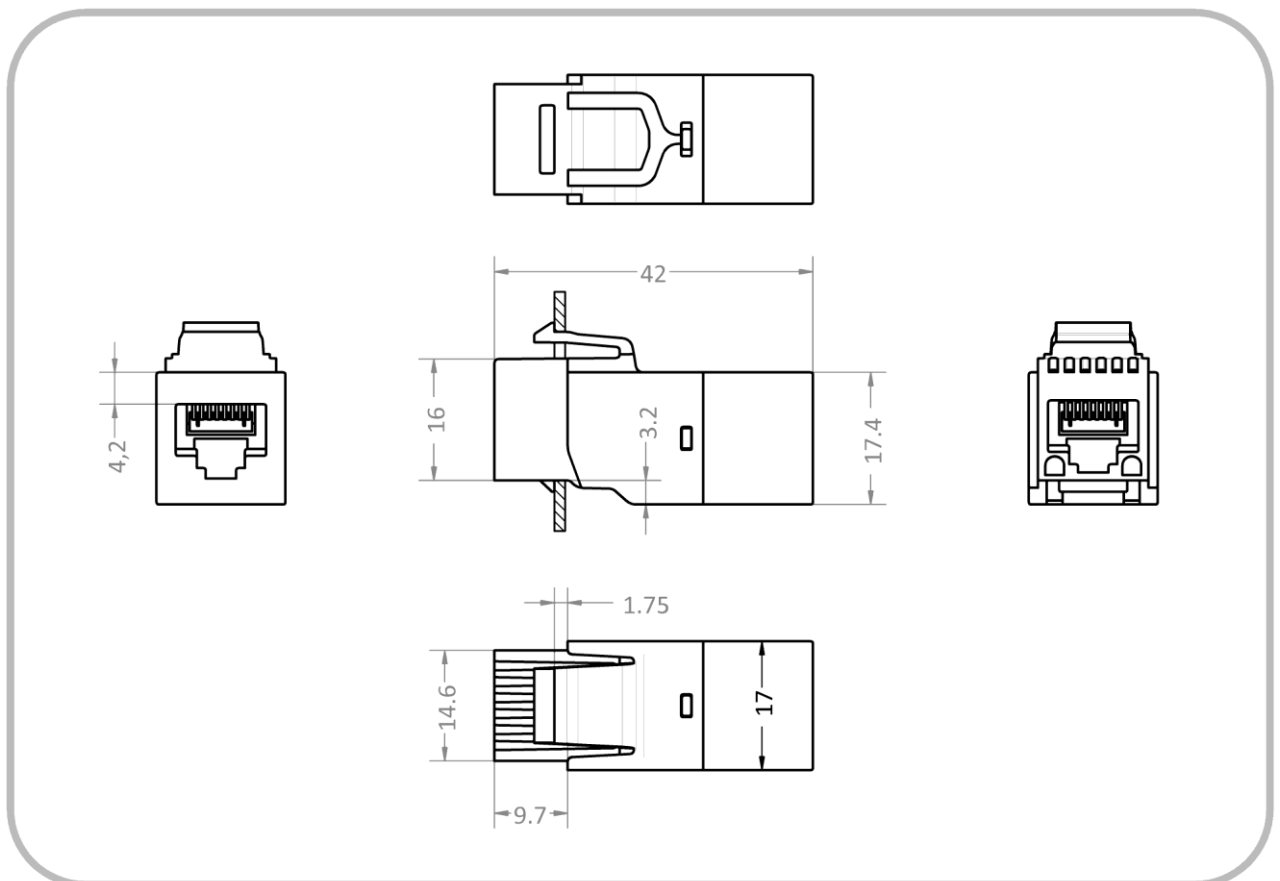

Figure 4. Physical dimensions for EN-70HD-K

## 5.5 EN-70VD-K

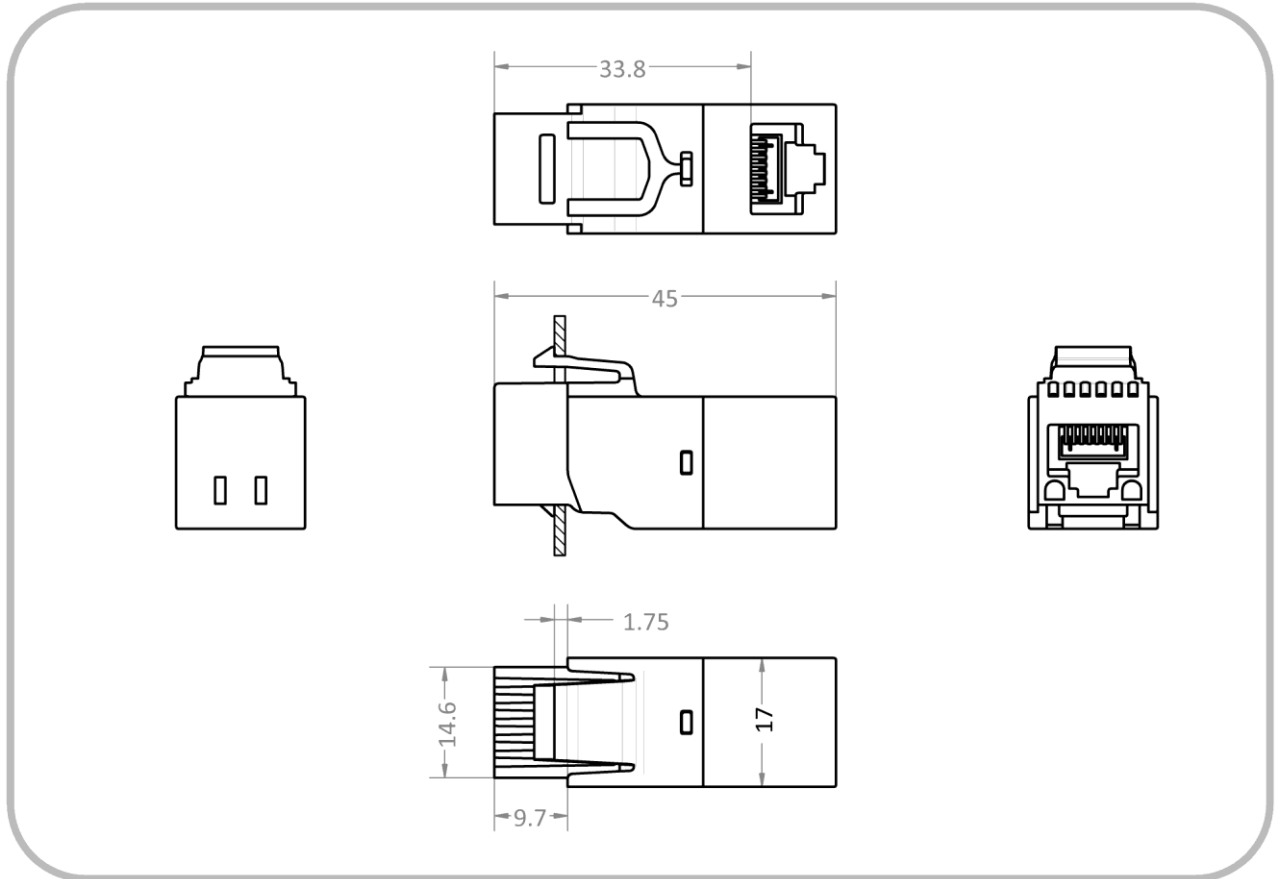

Figure 5. Physical dimensions for EN-70VD-K

## 6 INSTALLATION INFORMATION

## 6.1 GENERAL

EN-70 Network Isolators are designed for data transmission in the frequency range of 300 kHz to 100 MHz. Lower frequencies are strongly attenuated. For this reason, it is generally not possible to transmit the signals from nurse call systems, telephone systems or analogue audio / video signals over a Network Isolator.

The EN-70 Network Isolator can be used in a Power over Ethernet (PoE) network without restriction (however PoE devices downstream of the electrical isolation are not supplied with power).

## 6.2 USE OF SNAPFIT INSTALLATION FRAMES

SnapFit installation frames can be obtained as accessories for EN-70HD-S; EN-70HD-S-B and EN-70VD-S, providing panel mounting which is secure and free from play. The physically square interface allows for four different attachment positions. The production of customer-specific SnapFit frames is possible upon request.

**ATTENTION:** *SnapFit installation frames are no longer removable after being snapped into place. Therefore please pay attention to the correct plug-in position when assembling!*

### 6.3 EQUIPMENT INSTALLATION

When designing Network Isolators into equipment or devices, it is essential that the manufacturer observes the applicable creepage and clearance distances. Specifically, the creepage and clearance distances between exposed metal surfaces of Ethernet patch cables plugged into the Network Isolator, and the next-closest electrically conducting components of the equipment or device to be protected. These distances must be designed to comply with the relevant requirements and standards. If needs be, this next-closest electrically conducting component must be appropriately bonded to the protective earth connection.

### 6.4 INSTALLATION OF KEYSTONE ISOLATORS IN CABLE CHANNELS OR MEDICAL SUPPLY UNITS

EN-70HD-K and EN-70VD-K Network Isolators can be snapped into any housing aperture which satisfies the Keystone dimension requirements described in section [6.5 KEYSTONE HOUSING APERTURE](#).

EN-70 Network Isolators also disconnect the shield connections in Ethernet cabling. If the cable shield of the incoming data cable is to be connected with the room or equipment potential, such a connection must be carried out separately before the Network Isolator, effectively bypassing the Network Isolator.

### 6.5 KEYSTONE HOUSING APERTURE

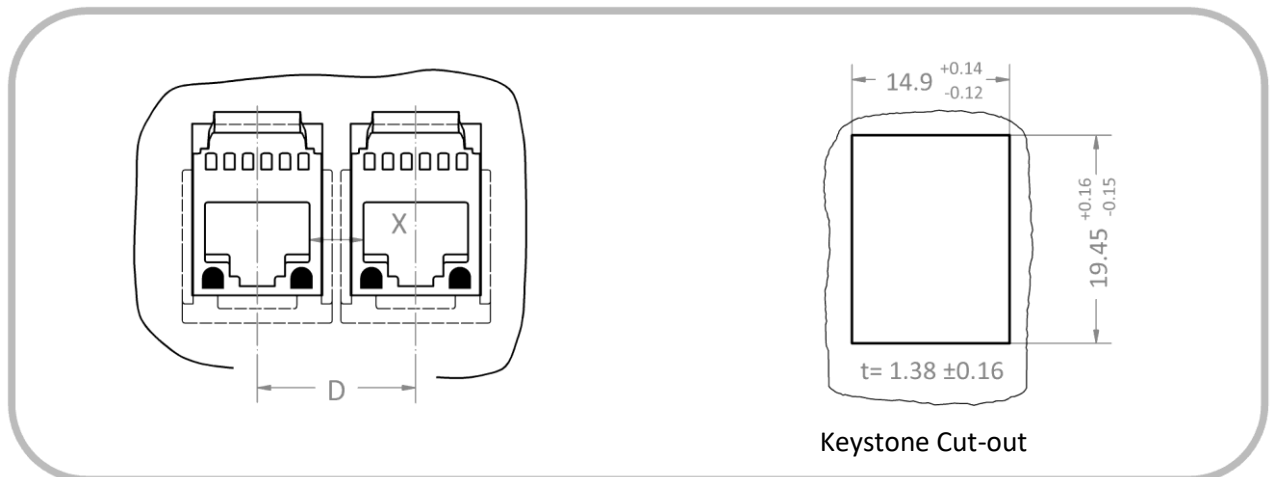

Figure 6. Mechanical dimensions for Keystone-compatible cut-outs, and required panel thickness.

The centre-to-centre separation "D" between two neighbouring Network Isolators is to be selected depending on the necessary clearance and creepage distance. Here, as a rule, the shortest separation "X" between the screening shields of the inserted Ethernet cables is crucial. See also section [6.6 ASSEMBLY IN MULTIPLE MODULE CARRIERS](#).

### 6.6 ASSEMBLY IN MULTIPLE MODULE CARRIERS

If it is intended that two or more EN-70 Network Isolators are to be installed side by side into a multiple module carrier, the mounting clearance must be taken into account. Crucial to this is the creepage distance between the screening shields of the patch cables inserted into neighbouring Network Isolators. The resulting creepage distance must not fall short of 8 mm in 250 V AC environments, and not less than 12 mm in 400 V AC environments. The centre-to-centre distance can be reduced if the creepage distance is increased accordingly (e.g. by adding plastic dividers).

Combining EN-70 Network Isolators and non-isolated modules within multiple module carriers is not recommended.

## 6.7 ELECTRICALLY ISOLATED WALL OUTLETS

EMOSAFE EN-70 Network Isolators can also be used to provide permanently installed Ethernet cabling with electrical isolation at the outlet termination. For an Ethernet cabling installation, including its termination of an EN-70 Network Isolator, to completely meet the requirements of Permanent Links according to ISO 11801 Class D or TIA/EIA 568 Cat.5e for Gigabit Ethernet, the cabling itself (without the Network Isolator) must provide a performance reserve. The following performance reserves to the Class D or Cat.5e limiting curves must be met without a Network Isolator:

NEXT:	<b>4.0 dB</b>
Return Loss:	<b>4.0 dB</b>
Insertion Loss:	<b>1.5 dB</b>

If a cabling installation which satisfies this requirement is terminated with an EN-70 Network Isolator, the installation as a whole will meet the requirements stated above. As required, this can then be verified using a cable certification device. For this, see also [8.1 FUNCTION AND COMPLIANCE TESTS](#).

**Note: The fitting of EN-70e in permanently laid cabling systems is not recommended, as the above given requirements cannot be met with certainty by this Network Isolator.**

## 7 SAFETY NOTICE

---

During assembly, attention should be paid (when applicable) to ensure that the clearance and creepage distances required by IEC 60601-1 are met. The isolating effect of the Network Isolator must not be compromised by neighbouring conductive components. If, for example, the installation of the Network Isolator is to be within a metal plate, this plate must be connected to the ground potential (protective earth).

As a matter of principle, Network Isolators should be mounted as close as possible to the equipment requiring protection.

Damaged Network Isolators, and Network Isolators which are contaminated by dust or liquids, are to be replaced.

## 8 FUNCTION AND SAFETY TESTS

---

### 8.1 FUNCTION AND COMPLIANCE TESTS

A cable run equipped with an EN-70 Network Isolator can be checked with regard to its transmission characteristics using cable certification devices which are suitable for testing an electrically isolated cable run. To be able to conduct such an inspection, the test equipment must be configured in an AC wire-map mode. With the installed Network Isolator, the entire cable run can be approved according to EIA/TIA-568 Cat.5e or ISO 11801 Class D. Testing of the cable shielding and the individual conductor resistance is not possible in such an AC test mode.



## 8.2 SAFETY INSPECTIONS

Regular safety inspections and post-repair inspections are not prescribed for Network Isolators in medical use, as Network Isolators themselves are not classified as medical electrical (ME) devices. However, together with a connected ME device, Network Isolators form part of an ME system, which altogether may be subject to statutory inspection. The test interval, as well as the requirements to be met for both regular safety inspections and post-repair inspections will be specified by the responsible organisation (e.g. manufacturer or operator as defined by the regulations), and based upon the applicable standards for the entire ME system.

To simplify implementation, the individual components of the ME system (in this case, the Network Isolator) can be tested separately. Here as well, the responsible organisation specifies the test parameters, test interval and in the event of a failed test, the consequences. Depending on the requirement profile, the test can include one or more of the following individual tests:

### 8.2.1 VISUAL INSPECTION

Check for evidence of external damage and ingress of substances; dust or liquids for example.

### 8.2.2 LEAKAGE CURRENT TEST

It is to be checked if the measured leakage current is still within the prescribed limits. For this purpose, test equipment which can perform equipment leakage current measurements in accordance with IEC 62353 may be used. To perform a leakage current test, all conductors on the input side must be short-circuited together, and all the conductors on the output side must also be short-circuited together. The AC test voltage specified by the responsible organisation is then applied across these two connections. Input and output sides are interchangeable. The expected current flow can be found in section [9 SPECIFICATIONS](#).

### 8.2.3 HIPOT TEST

To ensure that the device under test is not damaged, it is recommended that a DC voltage source is used in place of the AC voltage source, and that the DC voltage is 1½ times that of the required AC voltage. The test setup is essentially the same as that of the Leakage Current Test above. The expected dielectric strength can be found in section [9 SPECIFICATIONS](#).

### 8.2.4 FUNCTIONAL TEST

After conducting the tests above, and reconnecting the Network Isolator into the Ethernet network, it is recommended to check whether the signal transmission is still performing correctly. Such a functional test can be performed, for example, with a suitable Ethernet cable certification device. See also section [8.1 FUNCTION AND COMPLIANCE TESTS](#).

## 9 SPECIFICATIONS

### 9.1 GENERAL

Category	Standards or Test Criteria	Properties	
Designation		EMOSAFE EN-70	
Housing colour		EN-70e:	White and Grey
		EN-70HD:	White and Black
		All other EN-70:	White
Housing Material		Plastic	
Construction		Self-Enclosed:	EN-70HD, EN70e
		Keystone:	EN-70HD-K, EN-70VD-K
		SnapFit:	EN-70HD-S, EN-70-HD-S-B, EN-70VD-S
Mounting Arrangement		Snap-lock:	Keystone
		Screws:	with SnapFit accessories
Input Interface		RJ45 Jack, straight	
Output Interface		RJ45 Jack, straight:	EN-70e, EN-70Hx-x
		RJ45 Jack, angled:	EN-70Vx-x
Weight		approximately 12 g	
Protection rating	EN 60529	IP40	
Mating cycles: Correct:	RJ45 plug in RJ45 socket	> 1000 cycles	
Mismatched:	with RJ11 / RJ12 / RJ25	maximum of 100 cycles	
Mean Time To Failure (MTTF)	SN 29500 Standard Temperature: 25°C Duty cycle: 100% (24 hours, 7 days)	EN-70e:	4,600 years
		All other EN-70:	3,260 years
	SN 29500 Standard Temperature: 40°C Duty cycle: 100% (24 hours, 7 days)	EN-70e:	4,260 years
		All other EN-70:	3,090 years

## 9.2 ETHERNET PERFORMANCE

Category	Standards or Test Criteria	EN-70e	All other EN-70
Transmission Speeds and Supported Network Protocols	10 Mbit/s, 10Base-T (IEEE802.3 Cl.14)	✓	✓
	100 Mbit/s, 100Base-Tx (IEEE802.3 Cl.25)	✓	✓
	1000 Mbit/s, 1000Base-T (IEEE802.3 Cl.40)	✓	✓
Performance Category	ISO 11801, Permanent Link (PL)	Class D	Class D
Insertion Loss (absolute) at 100 MHz	Typical:	1.0 dB	0.7 dB
	Maximum:	1.5 dB	1.0 dB
Return Loss (absolute) at 100 MHz	Typical:	17.0 dB	20.0 dB
	Minimum:	14.0 dB	16.0 dB

## 9.3 ELECTRICAL

Category	Standards or Test Criteria	EN-70e	All other EN-70
AC Dielectric Strength	at 50 Hz, for 60 seconds	4.6 kV	5.0 kV
DC Dielectric Strength	for 60 seconds	8.5 kV	8.5 kV
Reinforced Isolation	IEC 60601-1	✓	✓
Coupling Capacitance per Channel		37.5 pF ±25%	37.5 pF ±25%
Total Coupling Capacitance		150 pF ±25%	150 pF ±25%
Total Leakage Current	275 V AC at 50 Hz	Typical:	12.0 µA
		Maximum:	16.0 µA
TVS diode circuitry	Suppression of transients on the signal lines	✗	✓

## 9.4 OPERATING CONDITIONS AND AREA OF APPLICATION

Category	Standards or Test Criteria	EN-70e	All other EN-70
Pollution Degree	IEC 61010	2 *	2 *
Overvoltage Category	IEC 60664-1	III	III
Maximum Working Voltage †	Maximum mains voltage of the connected devices, in accordance with IEC 60601-1	400 V AC 450 V DC	400 V AC 450 V DC
Temperature		Minimum:	-10°C
		Maximum:	+70°C
Air Humidity	Non-condensing	Minimum:	10%
		Maximum:	90%
Air Pressure		Minimum:	700 hPa
		Maximum:	1,060 hPa
Altitude		Maximum:	3,200 m

## 9.5 ENVIRONMENTAL CONDITIONS: STORAGE AND TRANSPORTATION

Category	Standards or Test Criteria	EN-70e	All other EN-70	
Temperature		Minimum:	-40°C	-40°C
		Maximum:	+70°C	+70°C
Air Humidity	Non-condensing	Minimum:	10%	10%
		Maximum:	90%	90%
Air Pressure		Minimum:	500 hPa	500 hPa
		Maximum:	1,060 hPa	1,060 hPa

## 9.6 CERTIFICATES

Category	EN-70e	All other EN-70
UL Recognized Component	✓	✓
UL File No.	E246126 E362969	E246126 E362969
IEC 60601-1	✓	✓
IEC 60601-1-2	✓	✓
ANSI/AAMI ES 60601-1	✓	✓
CAN/CSA-C22.2 No. 60601-1	✓	✓
Low Voltage Directive	✓	✓
EMC Directive	✓	✓
RoHS Directive	✓	✓
Lead-free	✓	✓

The versions of the cited standards and directives to which our products comply with can be found in our Declaration of Conformity and our UL certificate on our website under "[Standard Conformity and Certificates](#)".

## 9.7 ISOLATION DIAGRAM

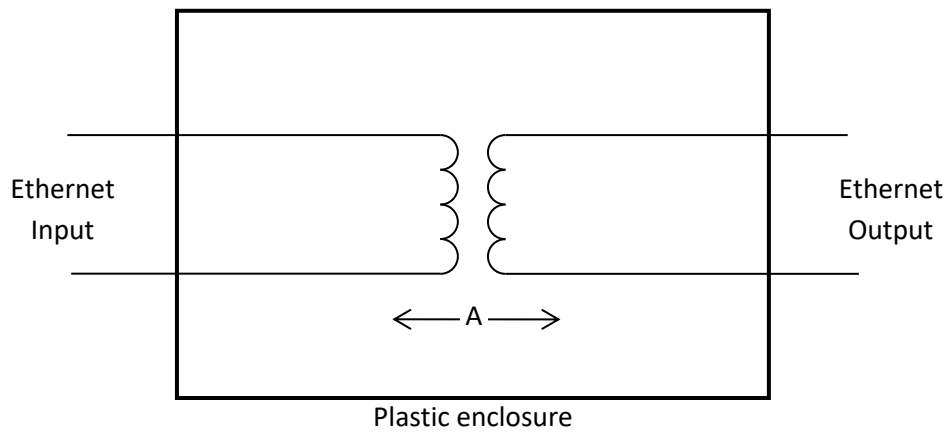

Figure 7. Isolation diagram for all EN-70

Area	Number and type of Means of Protection	Material Group (from CTI)	Maximum Operating Voltage		Required creepage distance (mm)	Required clearance distance (mm)	Measured creepage distance (mm)	Measured clearance distance (mm)
			V AC	V <sub>peak</sub>				
A	2 MOPP *	IIIb †	400	565	12.0	7.0	12.0	9.0

\* MOPP = Means of Patient Protection

† Materials in the Material Group IIIb have a Comparative Tracking Index (CTI) value between 100 and 175.

## 9.8 FREQUENCY RESPONSE

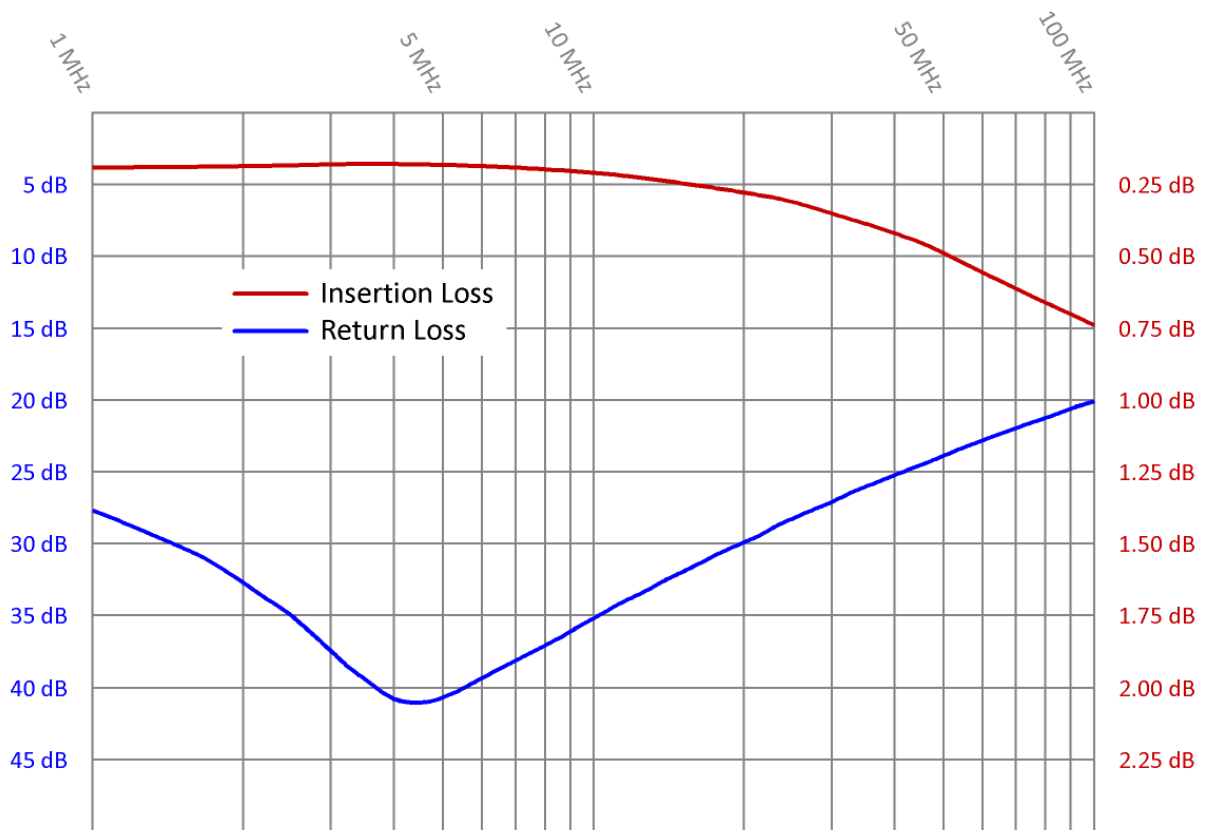

Figure 8. Typical frequency response for Insertion Loss and Return Loss of an EMOSAFE EN-70HD Network Isolator.

## 10 SCHEMATIC DIAGRAM

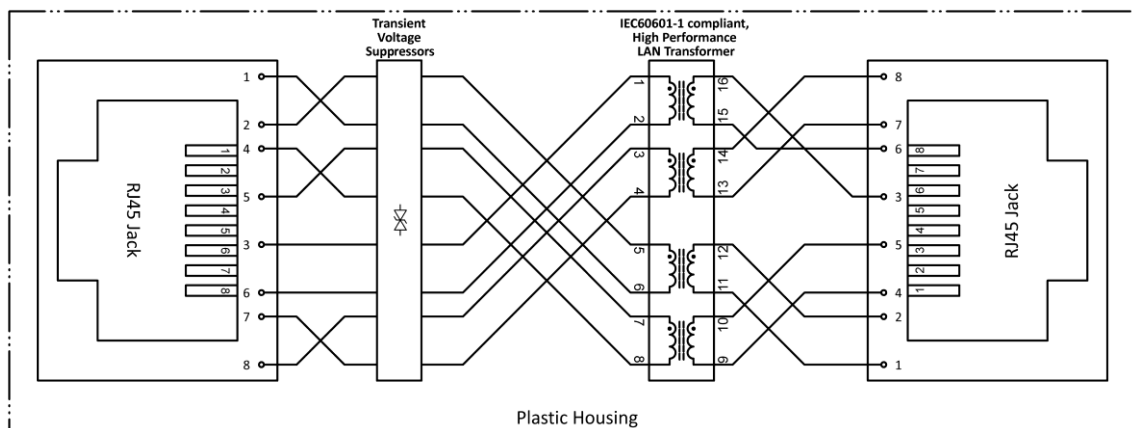

Figure 9. Circuit diagram for all EN-70 variants, with the exception of EN-70e.

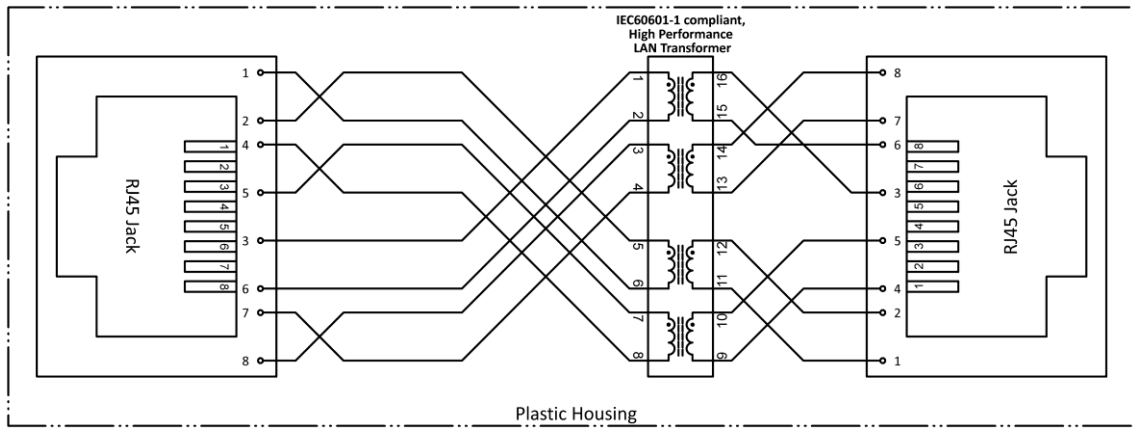

Figure 10. Circuit diagram for EN-70e.

## 11 SCHEDULED MAINTENANCE

EMOSAFE network isolators are maintenance-free when used as intended.

## 12 PRODUCT MARKINGS

	<p>Through this mark, the conformity of the product with all applicable EU Directives is confirmed.</p>
	<p>Marks the product as a UL "Recognised Component"; File No. E362969.</p>
	<p>The product may not be disposed of in domestic rubbish.</p>
	<p>This product contains no substances containing lead and is manufactured using lead-free solder.</p>
	<p>This product meets the requirements of EU Directive concerning the limitation of the use of certain hazardous substances in electric and electronic equipment.</p>

## 13 ACCESSORIES

SnapFit installation frames are available as accessories. They are used to securely and play-free fastening of the EN-70HD-S, EN-70-HD-S-B and EN-70VD-S network isolators to housing walls. The square interface allows for four different attachment positions.

The production of customer specific SnapFit frames is possible upon request.

# SnapFit

Installation frame for SnapFit variants

	Name	Special features	Configuration
	<b>Z-3-SF-INT</b> Article number A10057	<ul style="list-style-type: none"> <li>Housing assembly for flush mounting</li> <li>Two M2.5 brass inserts</li> <li>Two snap-fit positions</li> <li>Material: polyamide, black</li> </ul>	
	<b>Z-4-SF-EXT</b> Article number A10058	<ul style="list-style-type: none"> <li>Protruding housing assembly</li> <li>Two snap-fit positions</li> <li>Material: polyamide, black</li> </ul>	

**ATTENTION: SnapFit installation frames can no longer be removed once they have been plugged in and snapped into place.**

**Therefore, be sure to ensure the correct plug-in position when plugging it on!**

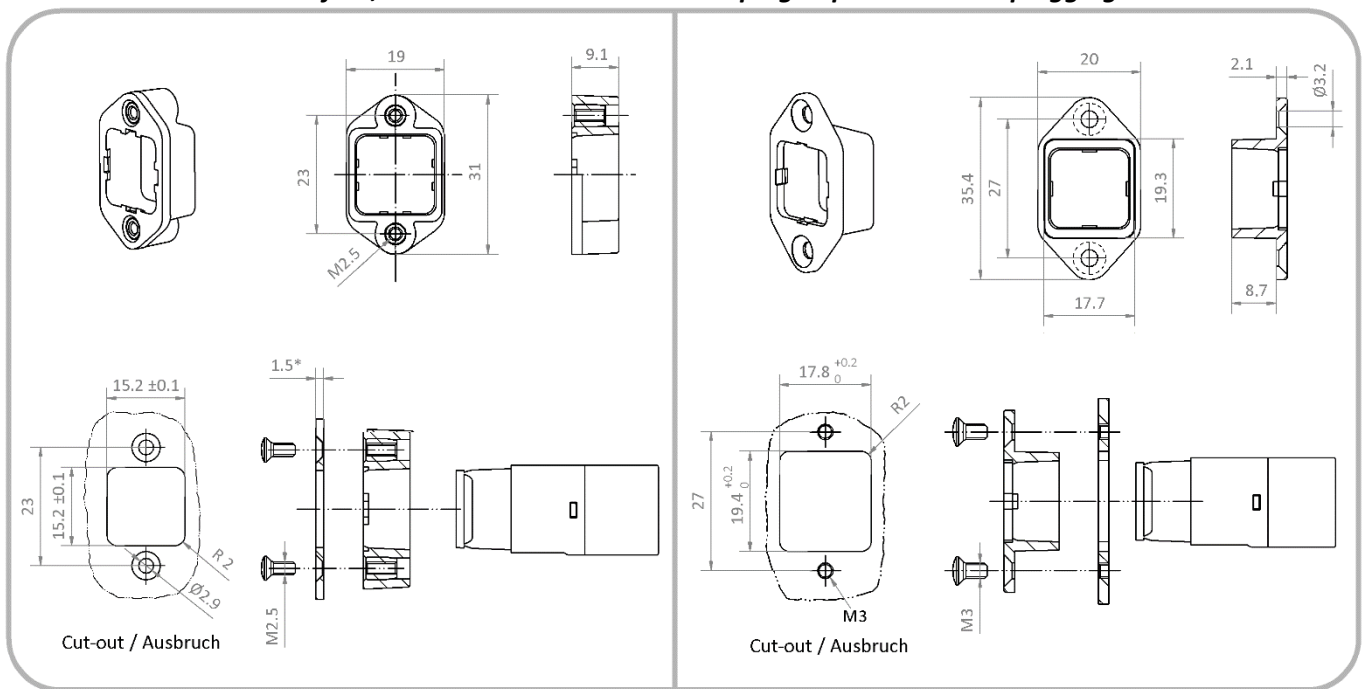

Dimensions of the SnapFit caps. All measurements in millimeters.  
 \* The dimension 1.5mm is recommended for flush mounting of the EN-66S.  
 However, different sheet thicknesses are possible.



## 14 QUALITY

---

EMO Systems GmbH maintains a certified quality management system for development and production in accordance with ISO 9001 and ISO 13485. Every network isolator is subjected to extensive quality control before delivery. Among other things, it is checked whether the achieved values for leakage current, dielectric strength, insertion loss, return loss and near crosstalk (NEXT) correspond to the specifications.

You will also find a declaration of conformity on our website confirming that the EMOSAFE network isolators comply with the requirements of the Low Voltage Directive (2014/35/EU), the Electromagnetic Compatibility Directive (2014/30/EU) and the Restriction of Use Directive hazardous substances in electrical and electronic equipment (2011/65/EU, RoHS).

## 15 PACKAGING

---

The packaging label provides the following information:

- Article description
- Quantity
- Date of manufacture
- Ordering code (OC)
- Serial number as 1D- (Code 128) and a 2D barcode (Data Matrix)

Contents:

- A network isolator of type EN-70e, EN-70HD, EN-70HD-K, EN-70VD-K, EN-70HD-S, EN-70-HD-S-B, EN-70VD-S

## 16 ENVIRONMENTAL PROTECTION INFORMATION

---

This device contains electronic components.

It must be returned to the manufacturer for disposal after use.

## 17 CONTACT AND SUPPORT

---

You can find the current contact details on our website: <https://emosystems.de/en/contact/>

Or you can reach us by email at the following address: [support@emosystems.de](mailto:support@emosystems.de)

## 18 LEGAL NOTICE

---

The information in this data sheet has been compiled to the best of our knowledge and with all care. However, we cannot guarantee that they are complete and error-free.

The user is responsible and liable for the correct use of this product. Neither EMO Systems GmbH nor EMO Systems Inc. assume liability.

This data sheet is subject to change without prior notice.